

34mm Half Bridge IGBT Module

电气特性:

- 1200V 沟槽栅/场终止工艺
- 低开关损耗
- 正温度系数

典型应用:

- 逆变焊机
- 感应加热
- 高频开关应用
- 逆变器

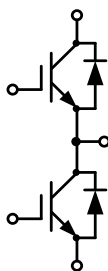

$V_{CES}=1200V$, $I_{C\ nom}=50A$ / $I_{CRM}=100A$

IGBT, 逆变器 / IGBT, Inverter

最大额定值 / Maximum Ratings

Parameter	Conditions	Symbol	Value	Unit
集电极-发射极电压 Collector-Emitter voltage	$T_{vj}=25^{\circ}C$	V_{CES}	1200	V
连续集电极直流电流 Continuous DC collector current	$T_C=100^{\circ}C$, $T_{vj\ max}=175^{\circ}C$	$I_{C\ nom}$	50	A
集电极重复峰值电流 Repetitive peak collector current	$t_p=1\ ms$	I_{CRM}	100	A
总功率损耗 Total power dissipation	$T_C = 25^{\circ}C$, $T_{vj\ max} = 175^{\circ}C$	P_{tot}	230	W
栅极-发射极电压 Gate emitter voltage		V_{GE}	± 20	V

特征值 / Characteristic Values

Parameter	Conditions	Symbol	Value			Unit
			Min.	Typ.	Max.	
集电极-发射极饱和电压 Collector-Emitter saturation voltage	$V_{GE}=15V$, $I_C=50A$ $V_{GE}=15V$, $I_C=50A$ $V_{GE}=15V$, $I_C=50A$	$T_{vj}=25^{\circ}C$ $T_{vj}=125^{\circ}C$ $T_{vj}=150^{\circ}C$	V_{CESat}	2.18 2.75 2.87	2.65	V
栅极-发射极阈值电压 Gate-Emitter threshold voltage	$I_C = 1.7mA$, $V_{GE}= V_{CE}$	$T_{vj}=25^{\circ}C$	$V_{GE(th)}$	5.20	5.80	6.40
栅电荷 Gate charge	$V_{GE}=-15V\dots+15V$		Q_G	0.26		μC
内部栅极电阻			R_{Gint}	3.12		Ω

Internal gate resistor						
输入电容 Input capacitance	f=1MHz, V _{CE} =25 V, V _{GE} =0 V T _{vj} =25°C	C _{ies}		3.72		nF
反向传输电容 Reverse transfer capacitance		C _{res}		0.12		
集电极-发射极截止电流 Collector-emitter cut-off current	V _{CE} =1200V, V _{GE} = 0 V T _{vj} =25°C	I _{CES}			1	mA
栅极-发射极漏电流 Gate-emitter leakage current	V _{CE} =0 V, V _{GE} = 20 V T _{vj} =25°C	I _{GES}			100	nA
开通延迟时间 Turn-on delay time	I _C =50A, V _{CE} =600 V V _{GE} =±15 V, R _G =15Ω (电感负载) / (inductive load)	T _{vj} =25°C T _{vj} =125°C T _{vj} =150°C	t _{d on}		60 64 64	ns
上升时间 Rise time	I _C =50A, V _{CE} =600 V V _{GE} =±15 V, R _G =15Ω (电感负载) / (inductive load)	T _{vj} =25°C T _{vj} =125°C T _{vj} =150°C	t _r		36 42 45	
关断延迟时间 Turn-off delay time	I _C =50A, V _{CE} =600 V V _{GE} =±15 V, R _G =15Ω (电感负载) / (inductive load)	T _{vj} =25°C T _{vj} =125°C T _{vj} =150°C	t _{d off}		158 181 209	
下降时间 Fall time	I _C =50A, V _{CE} =600 V V _{GE} =±15 V, R _G =15Ω (电感负载) / (inductive load)	T _{vj} =25°C T _{vj} =125°C T _{vj} =150°C	t _f		111 129 199	
开通损耗能量（每脉冲） Turn-on energy loss per pulse	I _C =50A, V _{CE} =600 V V _{GE} =±15 V, R _G =15Ω (电感负载) / (inductive load)	T _{vj} =25°C T _{vj} =125°C T _{vj} =150°C	E _{on}		3.27 5.01 6.31	mJ
关断损耗能量（每脉冲） Turn-off energy loss per pulse	I _C =50A, V _{CE} =600 V V _{GE} =±15 V, R _G =15Ω (电感负载) / (inductive load)	T _{vj} =25°C T _{vj} =125°C T _{vj} =150°C	E _{off}		1.91 2.36 2.72	
短路数据 SC data	V _{GE} ≤15V, V _{CC} =800V V _{CEmax} =V _{CES} -L _{sCE} ·di/dt t _p ≤10us, T _{vj} =150°C	I _{SC}			164	A
结-外壳热阻 Thermal resistance, junction to case	每个 IGBT / per IGBT	R _{thJC}			0.65	K/W
在开关状态下温度 Temperature under switching conditions		T _{vj op}	-40		150	°C

二极管，逆变器 / Diode, Inverter

最大额定值 / Maximum Ratings

Parameter	Conditions	Symbol	Value	Unit
反向重复峰值电压 Repetitive peak reverse voltage	T _{vj} =25°C	V _{RRM}	1200	V
连续正向直流电流 Continuous DC forward current		I _F	50	A
正向重复峰值电流 Repetitive peak forward current	t _p =1ms	I _{FRM}	100	A
I ² t 值 I ² t-value	t _p =10ms, sin180°, T _{vj} =125°C	I ² t	613	A ² s

特征值 / Characteristic Values

Parameter	Conditions	Symbol	Value			Unit
			Min.	Typ.	Max.	
正向电压 Forward voltage	$I_F=50A, V_{GE}=0V$ $I_F=50A, V_{GE}=0V$ $I_F=50A, V_{GE}=0V$	$T_{vj}=25^{\circ}C$ $T_{vj}=125^{\circ}C$ $T_{vj}=150^{\circ}C$	V_F	2.20 1.74 1.65	2.70	V
反向恢复峰值电流 Peak reverse recovery current	$I_F=50A,$ $-di_F/dt=1226A/\mu s(T_{vj}=150^{\circ}C)$ $V_R=600V, V_{GE}=-15V$	$T_{vj}=25^{\circ}C$ $T_{vj}=125^{\circ}C$ $T_{vj}=150^{\circ}C$	I_{RM}	14 27 29		A
恢复电荷 Recovered charge	$I_F=50A,$ $-di_F/dt=1226A/\mu s(T_{vj}=150^{\circ}C)$ $V_R=600V, V_{GE}=-15V$	$T_{vj}=25^{\circ}C$ $T_{vj}=125^{\circ}C$ $T_{vj}=150^{\circ}C$	Q_r	1.91 5.51 6.60		μC
反向恢复损耗（每脉冲） Reverse recovered energy	$I_F=50A,$ $-di_F/dt=1226A/\mu s(T_{vj}=150^{\circ}C)$ $V_R=600V, V_{GE}=-15V$	$T_{vj}=25^{\circ}C$ $T_{vj}=125^{\circ}C$ $T_{vj}=150^{\circ}C$	E_{rec}	0.61 1.64 1.96		mJ
结-外壳热阻 Thermal resistance, junction to case	每个二极管 / per diode		R_{thJC}		1.05	K/W
在开关状态下温度 Temperature under switching conditions			$T_{vj op}$	-40	150	$^{\circ}C$

模块 / Module

Parameter	Conditions	Symbol	Value			Unit
绝缘测试电压 Isolation test voltage	RMS, $f=50Hz, t=1min$	V_{ISOL}	2500			V
内部绝缘 Internal isolation			Al ₂ O ₃			
储存温度 Storage temperature		T_{stg}	-40		125	$^{\circ}C$
模块安装的扭矩 Mounting torque for modul mounting		M	3.0		6.0	Nm
重量 Weight		W		155		g



图 1. 典型输出特性 ($V_{GE}=15V$)

Figure 1. Typical output characteristics ($V_{GE}=15V$)

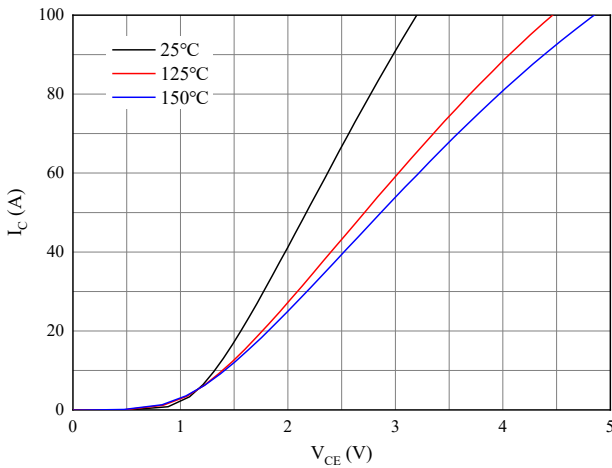

图 2. 典型输出特性 ($T_{vj}=150^{\circ}C$)

Figure 2. Typical output characteristics ($T_{vj}=150^{\circ}C$)

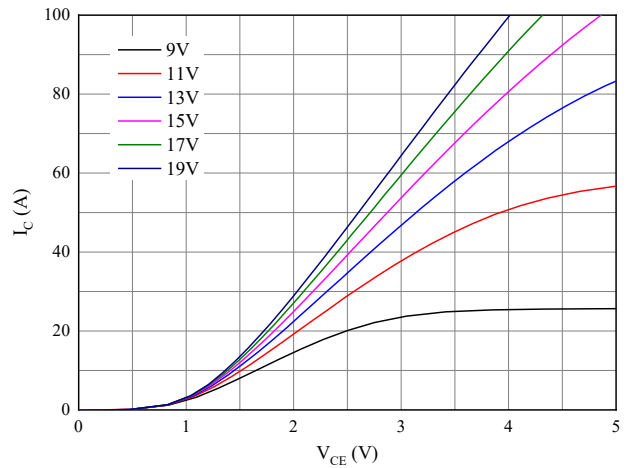

图 3. 典型传输特性($V_{CE}=20V$)

Figure 3. Typical transfer characteristic($V_{CE}=20V$)

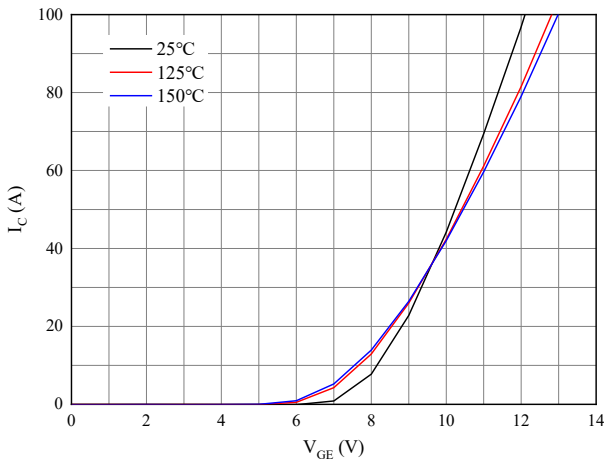

图 4. 正向偏压特性 二极管

Figure 4. Forward characteristic of Diode

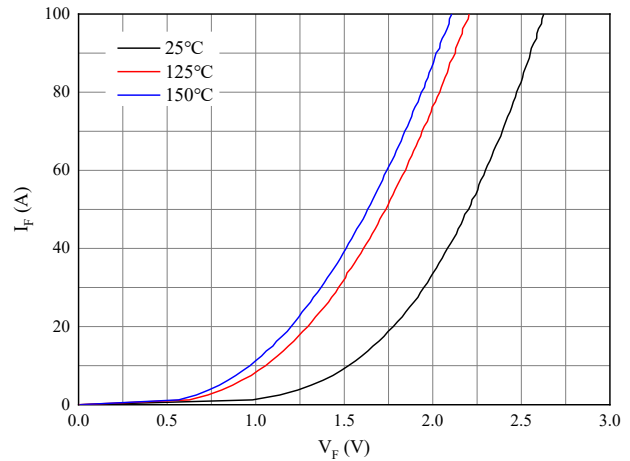

图 5. 开关损耗 逆变器

Figure 5. Switching losses of IGBT
 $V_{GE}=\pm 15V, R_{Gon}=15\Omega, R_{Goff}=15\Omega, V_{CE}=600V$

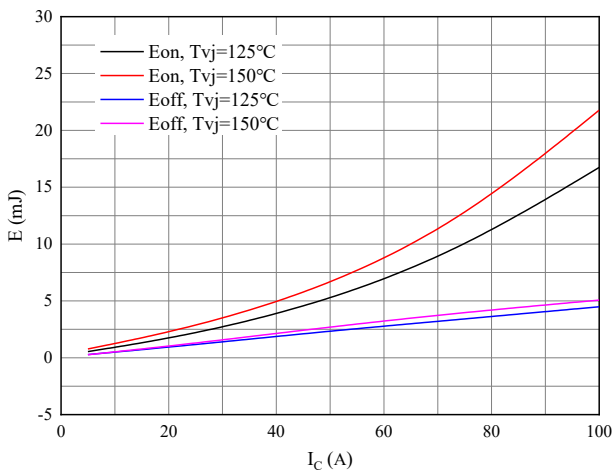

图 6. 开关损耗 逆变器

Figure 6. Switching losses of IGBT
 $V_{GE}=\pm 15V, I_C=50A, V_{CE}=600V$

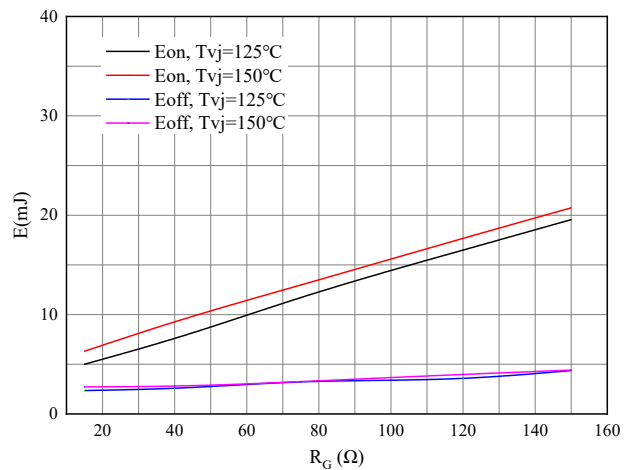

图 7. 开关损耗 二极管

Figure 7. Switching losses of Diode

$R_{Gon}=15\ \Omega, V_{CE}=600V$

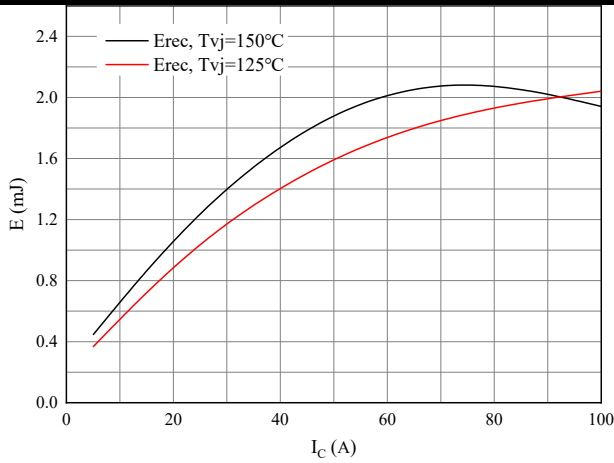

图 8. 开关损耗 二极管

Figure 8. Switching losses of Diode

$I_F=50A, V_{CE}=600V$

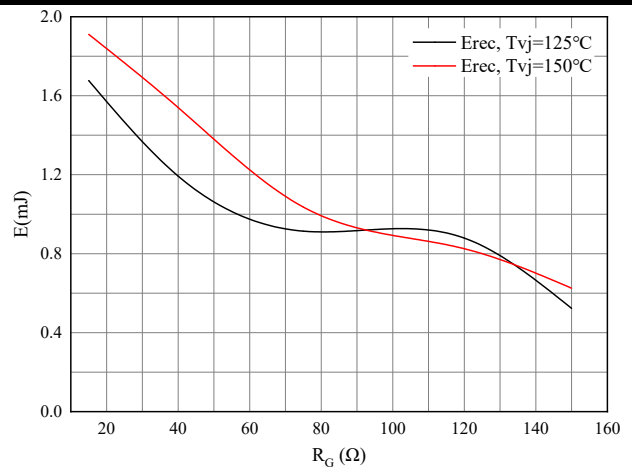

图 9. 电容特性

Figure 9. Capacitance characteristic

接线图 / Circuit diagram

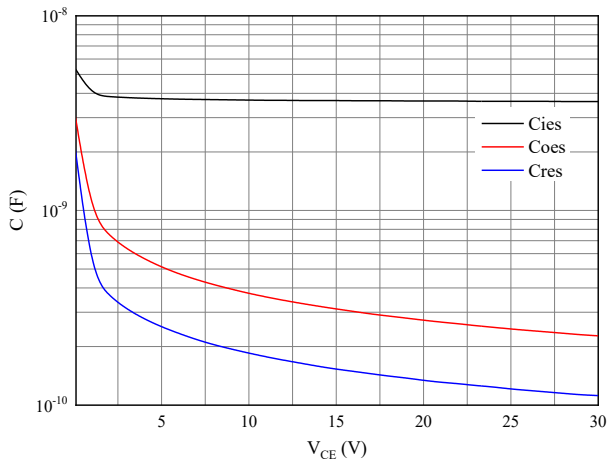
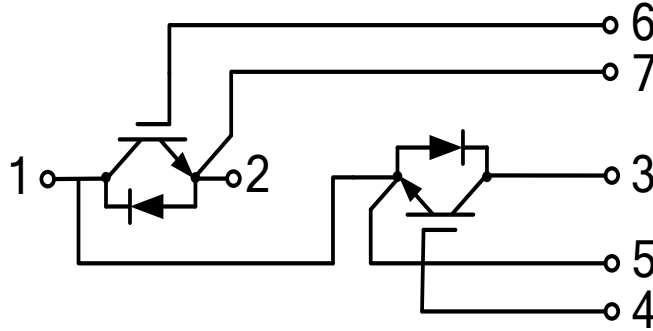

封装尺寸 / Package outlines

